

DS9638

RS-422 Dual High Speed Differential Line Driver

General Description

The DS9638 is a Schottky, TTL compatible, dual differential line driver designed specifically to meet the EIA Standard RS-422 specifications. It is designed to provide unipolar differential drive to twisted pair or parallel wire transmission lines. The inputs are TTL compatible. The outputs are similar to totem pole TTL outputs, with active pull-up and pull-down. The device features a short circuit protected active pull-up with low output impedance and is specified to drive 50Ω transmission lines at high speed. The mini-DIP provides high package density.

Features

- Single 5V supply
- Schottky technology
- TTL and CMOS compatible inputs
- Output short circuit protection
- Input clamp diodes
- Complementary outputs
- Minimum output skew (<1.0 ns typical)
- 50 mA output drive capability for 50Ω transmission lines
- Meets EIA RS-422 specifications
- Propagation delay of less than 10 ns
- "Glitchless" differential output
- Delay time stable with V_{CC} and temperature variations (<2.0 ns typical) (Figure 3)
- Extended temperature range

Connection Diagram

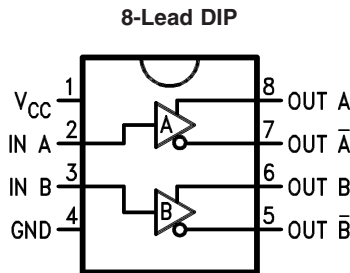

00962201

Top View

Order Number DS9638CM or DS9638CN
 See NS Package Number M08A or N08E
 For Complete Military Product Specifications,
 refer to the appropriate SMD or MDS.
 Order Number DS9638MJ/883
 See NS Package Number J08A

Absolute Maximum Ratings (Note 2)

If Military/Aerospace specified devices are required, please contact the National Semiconductor Sales Office/Distributors for availability and specifications.

Storage Temperature Range

Ceramic DIP	-65°C to +175°C
Molded DIP and SO-8	-65°C to +150°C

Lead Temperature

Ceramic DIP (Soldering, 60 sec.) 300°C

Molded DIP (Soldering, 10 sec.) 265°C

Maximum Power Dissipation (Note 1) at 25°C

Cavity Package 1300 mW

Molded Package 930 mW

SO Package 810 mW

 V_{CC} Lead Potential to Ground -5V to 7V

Input Voltage -0.5V to +7V

Recommended Operating Conditions

	DS9638M			DS9638C			Units
	Min	Typ	Max	Min	Typ	Max	
Supply Voltage (V_{CC})	4.5	5.0	5.5	4.75	5.0	5.25	V
Output Current HIGH (I_{OH})			-50			-50	mA
Output Current LOW (I_{OL})			50	40		50	mA
Operating Temperature (T_A)	-55	25	125	0	25	70	°C

Note 1: Derate cavity package 8.7 mW/°C above 25°C; derate molded DIP package 7.5 mW/°C above 25°C; derate SO package 6.5 mW/°C above 25°C.

Electrical Characteristics (Notes 3, 4)

Over recommended operating temperature and supply voltage ranges, unless otherwise specified

Symbol	Parameter	Conditions	Min	Typ	Max	Units
V_{IH}	Input Voltage HIGH		2.0			V
V_{IL}	Input Voltage LOW	0°C to +70°C -55°C to +125°C			0.8 0.5	V
V_{IC}	Input Clamp Voltage	$V_{CC} = \text{Min}$, $I_I = -18 \text{ mA}$		-1.0	-1.2	V
V_{OH}	Output Voltage HIGH	$V_{CC} = \text{Min}$, $V_{IH} = V_{IH \text{ Min}}$, $V_{IL} = V_{IL \text{ Max}}$	$I_{OH} = -10 \text{ mA}$ $I_{OH} = -40 \text{ mA}$	2.5 2.0	3.5	V
V_{OL}	Output Voltage LOW	$V_{CC} = \text{Min}$, $V_{IH} = V_{IH \text{ Min}}$, $V_{IL} = V_{IL \text{ Max}}$, $I_{OL} = 40 \text{ mA}$			0.5	V
I_I	Input Current at Maximum Input Voltage	$V_{CC} = \text{Max}$, $V_I \text{ Max} = 5.5 \text{ V}$			50	μA
I_{IH}	Input Current HIGH	$V_{CC} = \text{Max}$, $V_{IH} = 2.7 \text{ V}$			25	μA
I_{IL}	Input Current LOW	$V_{CC} = \text{Max}$, $V_{IL} = 0.5 \text{ V}$			-200	μA
I_{OS}	Output Short Circuit Current	$V_{CC} = \text{Max}$, $V_O = 0 \text{ V}$ (Note 4)	-50		-150	mA
V_T, \bar{V}_T	Terminated Output Voltage	See Figure 1	2.0			V
$V_T - \bar{V}_T$	Output Balance				0.4	V
V_{OS}, \bar{V}_{OS}	Output Offset Voltage				3.0	V
$V_{OS} - \bar{V}_{OS}$	Output Offset Balance				0.4	V
I_X	Output Leakage Current	$T_A = 25^\circ \text{C}$ $-0.25 \text{ V} < V_X < 5.5 \text{ V}$			100	μA
I_{CC}	Supply Current (Both Drivers)	$V_{CC} = 5.5 \text{ V}$, All input at 0V, No Load		45	65	mA

Note 2: "Absolute Maximum Ratings" are those values beyond which the safety of the device cannot be guaranteed. They are not meant to imply that the devices should be operated at these limits. The tables of "Electrical Characteristics provide conditions for actual device operation.

Note 3: Unless otherwise specified min/max limits apply across the -55°C to +125°C temperature range for the DS9638M and across the 0°C to +70°C range for the DS9638C. All typicals are given for $V_{CC} = 5 \text{ V}$ and $T_A = 25^\circ \text{C}$.

Note 4: All currents into the device pins are positive; all currents out of the device pins are negative. All voltages are referenced to ground unless otherwise specified.

Note 5: Only one output at a time should be shorted.

Switching Characteristics

$V_{CC} = 5.0V, T_A = 25^\circ C.$

Symbol	Parameter	Conditions	Min	Typ	Max	Units
t_{PHL}	Propagation Delay	$C_L = 15\text{ pF}$ $R_L = 100\Omega, \text{ See Figure 2}$		10	20	ns
t_{PLH}				10	20	ns
t_f	Fall Time, 90%–10%			10	20	ns
t_r	Rise Time, 10%–90%			10	20	ns
$t_{PO} - \overline{t_{PO}}$	Skew Between Outputs A/\overline{A} and B/\overline{B}			1.0		ns

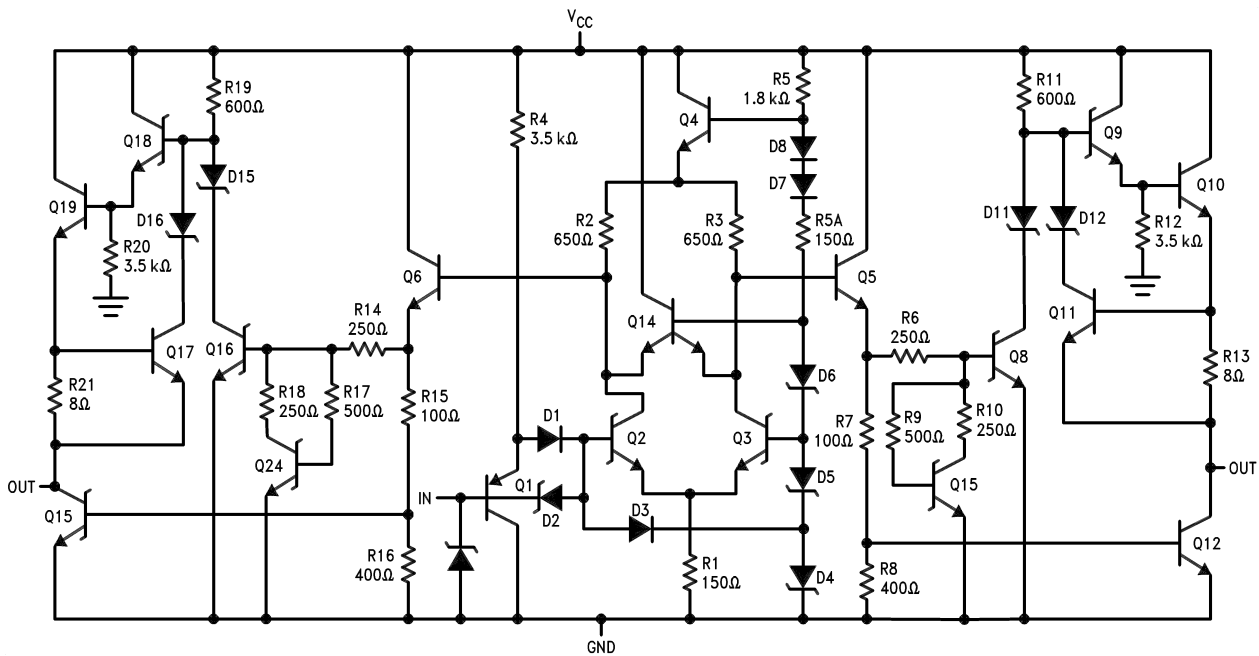

00962202

FIGURE 1. Equivalent Circuit

DC Test Circuit

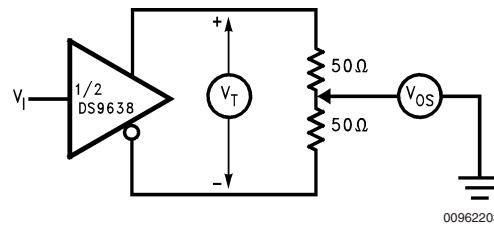

00962203

FIGURE 2. Terminated Output Voltage and Output Balance

DC Test Circuit (Continued)

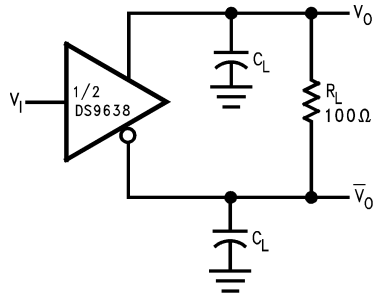

00962204

Note 6: The pulse generator has the following characteristics:

C_L includes probe and jig capacitance.

PRR = 500 kHz, $t_W = 100$ ns,

$t_r \leq 5.0$ ns, $Z_O = 50\Omega$.

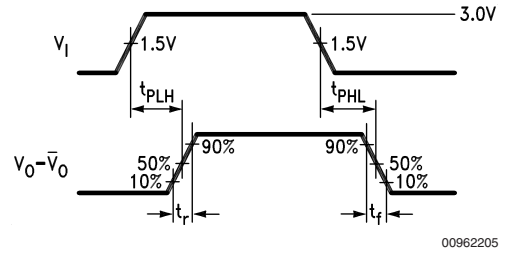

00962205

FIGURE 3. AC Test Circuit and Voltage Waveform

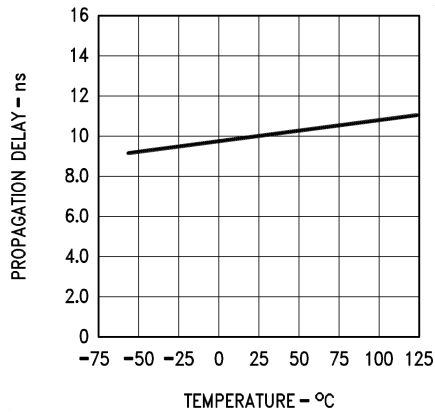

00962206

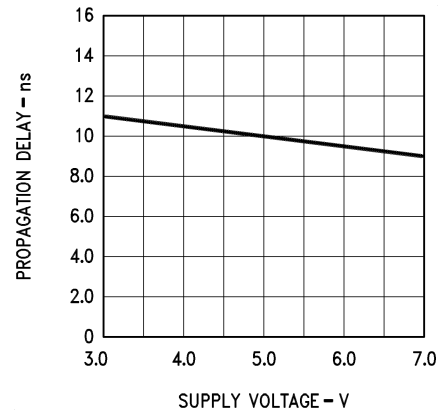

00962207

FIGURE 4. Typical Delay Characteristics

Physical Dimensions inches (millimeters) unless otherwise noted (Continued)

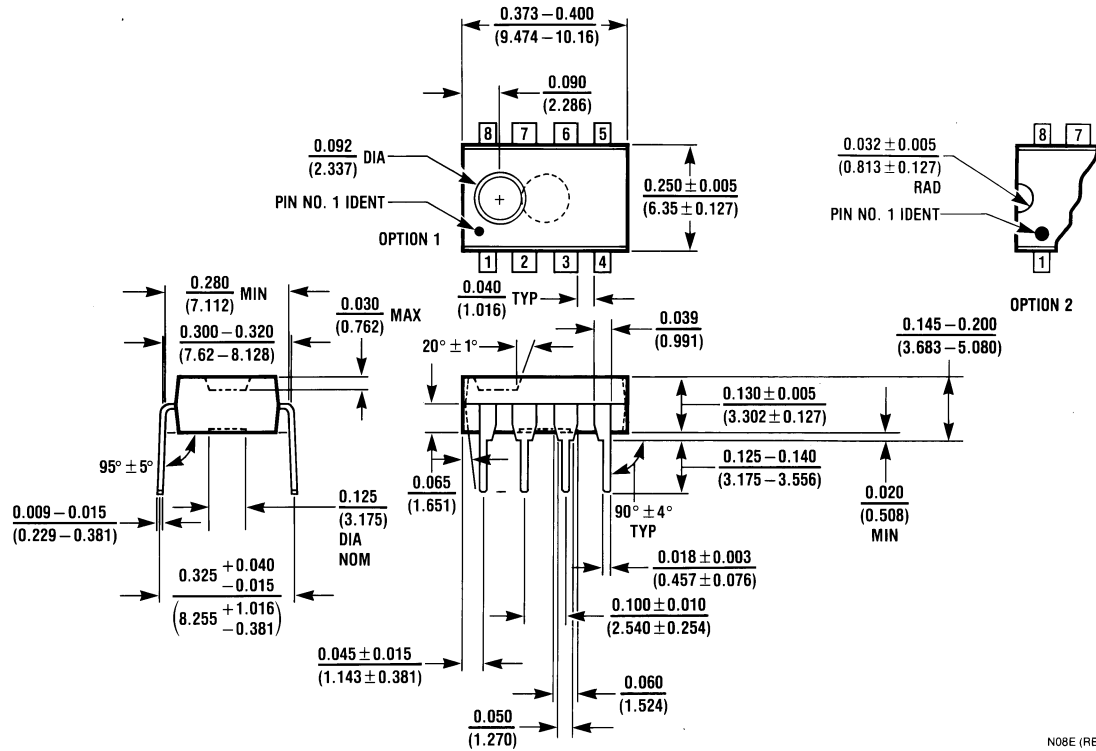

Molded Dual-In-Line Package (N)
Order Number DS9638CN
NS Package Number N08E

N08E (REV F)

National does not assume any responsibility for use of any circuitry described, no circuit patent licenses are implied and National reserves the right at any time without notice to change said circuitry and specifications.

For the most current product information visit us at www.national.com.

LIFE SUPPORT POLICY

NATIONAL'S PRODUCTS ARE NOT AUTHORIZED FOR USE AS CRITICAL COMPONENTS IN LIFE SUPPORT DEVICES OR SYSTEMS WITHOUT THE EXPRESS WRITTEN APPROVAL OF THE PRESIDENT AND GENERAL COUNSEL OF NATIONAL SEMICONDUCTOR CORPORATION. As used herein:

1. Life support devices or systems are devices or systems which, (a) are intended for surgical implant into the body, or (b) support or sustain life, and whose failure to perform when properly used in accordance with instructions for use provided in the labeling, can be reasonably expected to result in a significant injury to the user.
2. A critical component is any component of a life support device or system whose failure to perform can be reasonably expected to cause the failure of the life support device or system, or to affect its safety or effectiveness.

BANNED SUBSTANCE COMPLIANCE

National Semiconductor certifies that the products and packing materials meet the provisions of the Customer Products Stewardship Specification (CSP-9-111C2) and the Banned Substances and Materials of Interest Specification (CSP-9-111S2) and contain no "Banned Substances" as defined in CSP-9-111S2.

 **National Semiconductor**
Americas Customer Support Center
 Email: new.feedback@nsc.com
 Tel: 1-800-272-9959

National Semiconductor
Europe Customer Support Center
 Fax: +49 (0) 180-530 85 86
 Email: europe.support@nsc.com
 Deutsch Tel: +49 (0) 69 9508 6208
 English Tel: +44 (0) 870 24 0 2171
 Français Tel: +33 (0) 1 41 91 8790

National Semiconductor
Asia Pacific Customer Support Center
 Email: ap.support@nsc.com

National Semiconductor
Japan Customer Support Center
 Fax: 81-3-5639-7507
 Email: jpn.feedback@nsc.com
 Tel: 81-3-5639-7560